

CORRAPOL®-BT

Durable Bitumen Corrugated Sheets
Technical Guide

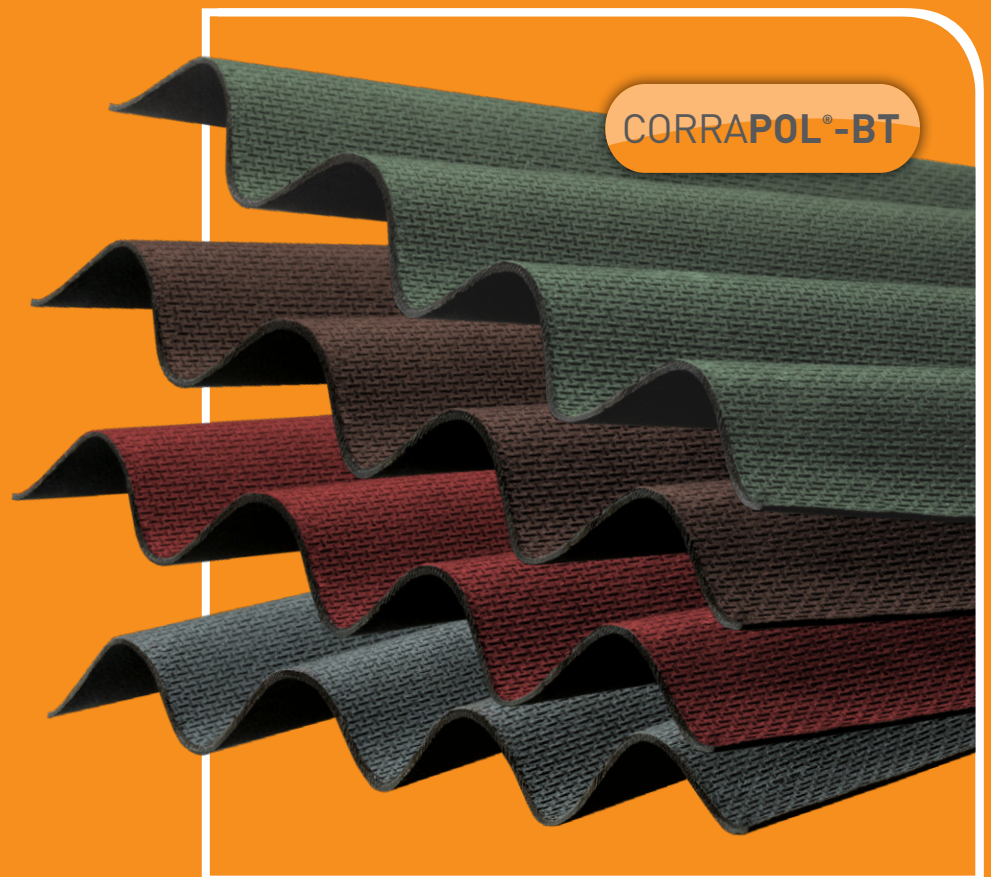

Waterproof Roofing Sheet

CORRAPOL®-BT is a Corrugated Bitumen impregnated sheet designed for waterproof roofing of sheds, log stores, garages and other outbuildings.

Available in several colours CORRAPOL®-BT sheets provide a roofing solution to suit many applications. CORRAPOL®-BT sheets are lightweight, easy to cut and quick to install.

Samples of CORRAPOL® sheets are readily available for testing and specification purposes.



Common uses:

- ✓ Sheds
- ✓ Garages
- ✓ Log Stores
- ✓ Children's Playhouses

Qualities:

- ✓ Lightweight
- ✓ Easy to Cut to Size
- ✓ Simple Overlap Joints
- ✓ Fast to Install



Black



Red

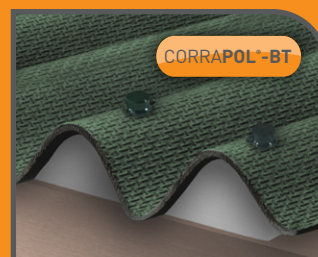

Green



Brown

CORRAPOL®-BT : Full Roof Structure

Below is a typical apex roof scenario showing how the CORRAPOL®-BT system components are installed together for perfect results. The same methods and components can be used in most applications from Carports, Decking covers, BBQ shelters and other constructions.



Refer to the *CORRAPOL®-BT Installation Guide*

CORRAPOL®-BT : Sheets

CORRAPOL®-BT sheets are manufactured in four colours to suit a wide variety of colour schemes to give an aesthetically pleasing finished projects.

CORRAPOL®-BT: Sheets	Size	Code
Corrugated Bitumen Sheet - Black	930 x 1000 mm	AC105BL
Corrugated Bitumen Sheet - Red	930 x 1000 mm	AC105RE
Corrugated Bitumen Sheet - Green	930 x 1000 mm	AC105GR
Corrugated Bitumen Sheet - Brown	930 x 1000 mm	AC105BR
Corrugated Bitumen Sheet - Black	930 x 2000 mm	AC110BL
Corrugated Bitumen Sheet - Red	930 x 2000 mm	AC110RE
Corrugated Bitumen Sheet - Green	930 x 2000 mm	AC110GR
Corrugated Bitumen Sheet - Brown	930 x 2000 mm	AC110BR

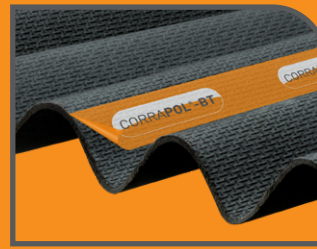

Black

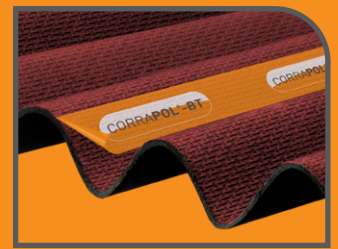

Red

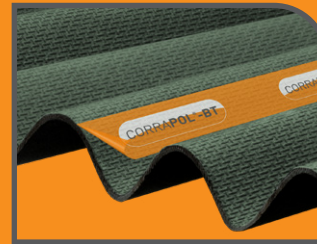

Green



Brown

AWNAPOL® : Sheets Premium

AWNAPOL® Premium Corrugated Bitumen Sheets share a similar style to our CORRAPOL®-BT Sheets but with enhanced rigidity provide a robust roofing solution, for a quality finish to any roofing product. With an extra level of quality, our AWNAPOL® Sheets are a great heavy-duty option for roofs such as garages, shed and more but remain lightweight and easy to cut and install.

Sharing the same profile as our CORRAPOL®-BT, AWNAPOL® corrugated sheets can be installed with all our CORRAPOL® Accessories, like the Rock N' Lock Flashings and Super Ridge.



Black

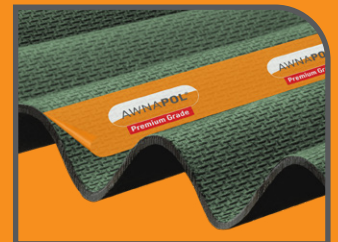

Green

AWNAPOL®: Premium Sheets	Size	Code
Premium Corrugated Bitumen Sheet - Black	930 x 2000 mm	OAC110BL
Premium Corrugated Bitumen Sheet - Green	930 x 2000 mm	OAC110GR

CORRAPOL®-BT : Rock n' Lock Gable Flashing

CORRAPOL®-BT Rock n' Lock Gable Flashing is a world first that we have manufactured to help our Distributors' Customers easily finish one of the most challenging areas of any roof project; the gable. The Patent Pending and Registered Design allows users to quickly and easily create a robust, long-lasting gable flashing to the gable end of any CORRAPOL®-BT roof.

CORRAPOL®-BT: Rock n' Lock Gable Flashing	Code
CORRAPOL®-BT Rock n' Lock Gable Flashing 2m - Black	AC220BL
CORRAPOL®-BT Rock n' Lock Gable Flashing 2m - Brown	AC220BR
CORRAPOL®-BT Rock n' Lock Gable Flashing 2m - Green	AC220GR
CORRAPOL®-BT Rock n' Lock Gable Flashing 2m - Red	AC220RE
CORRAPOL®-BT Rock n' Lock Gable Flashing 3m - Black	AC222BL
CORRAPOL®-BT Rock n' Lock Gable Flashing 3m - Brown	AC222BR
CORRAPOL®-BT Rock n' Lock Gable Flashing 3m - Green	AC222GR
CORRAPOL®-BT Rock n' Lock Gable Flashing 3m - Red	AC222RE
CORRAPOL®-BT Rock n' Lock Gable Flashing 6m - Black	AC228BL
CORRAPOL®-BT Rock n' Lock Gable Flashing 6m - Brown	AC228BR
CORRAPOL®-BT Rock n' Lock Gable Flashing 6m - Green	AC228GR
CORRAPOL®-BT Rock n' Lock Gable Flashing 6m - Red	AC228RE



Black



Red



Green



Brown

CORRAPOL®-BT : Three Stage Gable Connection

This patented CORRAPOL®-BT Rock n' Lock system means the gable flashing is locked in position providing a strong and aesthetically pleasing finish. The CORRAPOL®-BT Rock n' Lock Gable Flashing is available in four colours to match the four sheet colour options.



CORRAPOL®-BT : Super Ridge

The CORRAPOL®-BT aluminium Super Ridge is another game changer in the corrugated market. Protecting the ridge of a roof is crucial and with the installation of the CORRAPOL®-BT Super Ridge you can add years of lifespan to your roof. Designed with integrated pre-formed foam gaskets to fit the corrugations of the CORRAPOL®-BT sheets, the CORRAPOL®-BT Super Ridge is an installer's dream. The patented design allows for a good variety of roof pitches with the gaskets being flexible enough to seal against the CORRAPOL®-BT sheets, and create a longer lasting superior ridge solution.

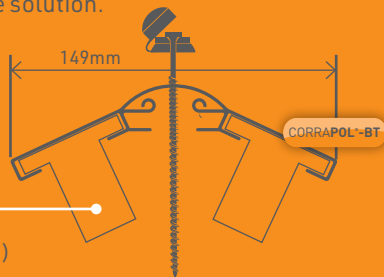

CORRAPOL®-BT Super Ridge Gasket (included)



CORRAPOL®-BT: Aluminium Super Ridge	Code
CORRAPOL®-BT Aluminium Super Ridge Set 2m - Black	AC330BL
CORRAPOL®-BT Aluminium Super Ridge Set 2m - Brown	AC330BR
CORRAPOL®-BT Aluminium Super Ridge Set 2m - Green	AC330GR
CORRAPOL®-BT Aluminium Super Ridge Set 2m - Red	AC330RE
CORRAPOL®-BT Aluminium Super Ridge Set 3m - Black	AC332BL
CORRAPOL®-BT Aluminium Super Ridge Set 3m - Brown	AC332BR
CORRAPOL®-BT Aluminium Super Ridge Set 3m - Green	AC332GR
CORRAPOL®-BT Aluminium Super Ridge Set 3m - Red	AC332RE
CORRAPOL®-BT Aluminium Super Ridge Set 6m - Black	AC338BL
CORRAPOL®-BT Aluminium Super Ridge Set 6m - Brown	AC338BR
CORRAPOL®-BT Aluminium Super Ridge Set 6m - Green	AC338GR
CORRAPOL®-BT Aluminium Super Ridge Set 6m - Red	AC338RE



CORRAPOL®-BT : Rock n' Lock Wall Flashing

The all new CORRAPOL®-BT Rock n' Lock Wall Flashing is another world first that we have manufactured to help installers complete a roofs gable when abutting up to a wall. Allowing users to quickly and easily create a robust, long-lasting wall flashing the Patent Pending and Registered Design makes it simple to fix and seal the wall end of any CORRAPOL®-BT roof. With the signature Rock n' Lock fixing system the CORRAPOL®-BT Rock n' Lock Wall Flashing locks into place to create an extra level of waterproofing.

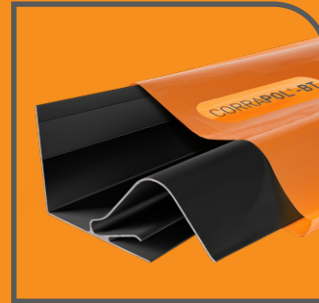

Black



Red

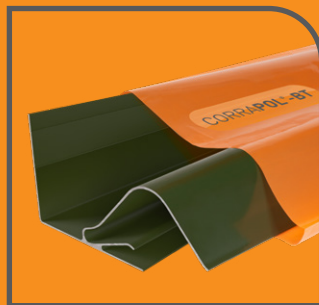

Green

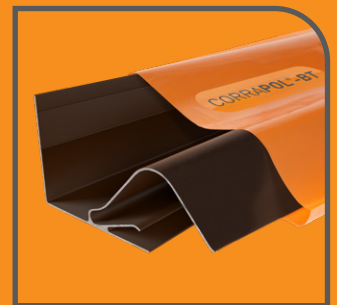

Brown

CORRAPOL®-BT: Rock n' Lock Wall Flashing	Code
CORRAPOL®-BT Rock n' Lock Wall Flashing 2m - Black	AC420BL
CORRAPOL®-BT Rock n' Lock Wall Flashing 2m - Brown	AC420BR
CORRAPOL®-BT Rock n' Lock Wall Flashing 2m - Green	AC420GR
CORRAPOL®-BT Rock n' Lock Wall Flashing 2m - Red	AC420RE
CORRAPOL®-BT Rock n' Lock Wall Flashing 3m - Black	AC422BL
CORRAPOL®-BT Rock n' Lock Wall Flashing 3m - Brown	AC422BR
CORRAPOL®-BT Rock n' Lock Wall Flashing 3m - Green	AC422GR
CORRAPOL®-BT Rock n' Lock Wall Flashing 3m - Red	AC422RE
CORRAPOL®-BT Rock n' Lock Wall Flashing 6m - Black	AC428BL
CORRAPOL®-BT Rock n' Lock Wall Flashing 6m - Brown	AC428BR
CORRAPOL®-BT Rock n' Lock Wall Flashing 6m - Green	AC428GR
CORRAPOL®-BT Rock n' Lock Wall Flashing 6m - Red	AC428RE

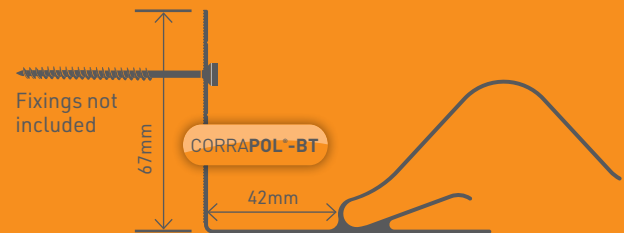

CORRAPOL®-BT : Three Stage Wall Connection

This patented CORRAPOL®-BT Rock n' Lock system means the wall flashing is locked in position providing a strong and aesthetically pleasing finish. The CORRAPOL®-BT Rock n' Lock Wall Flashing is available in four colours to match the four sheet colour options.

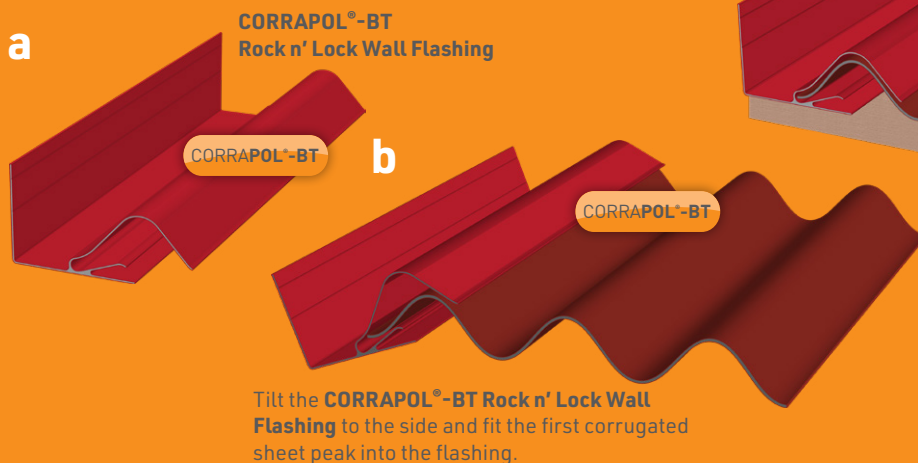

Lock the **CORRAPOL®-BT Rock n' Lock Wall Flashing** into place giving a waterproof and visually pleasing finish to the edge of your roof structure.

Tilt the **CORRAPOL®-BT Rock n' Lock Wall Flashing** to the side and fit the first corrugated sheet peak into the flashing.

CORRAPOL®-BT : Aluminium Super Ridge End Cap

Crafted with striking form, our all new CORRAPOL®-BT Super Ridge End Cap is designed to be the crowning element to every CORRAPOL®-BT Corrugated ridged roof. Shaped to add new level of waterproofing to the end of a CORRAPOL®-BT Super Ridge, the new Super Ridge End Cap helps protect one of the most crucial areas of installation and provides an unrivalled finish to user's roofs. Manufactured from aluminium, the new CORRAPOL®-BT Super ridge is very durable and adds extra longevity to the lifespan a roof. The simple and innovative location prongs ensure that installation is fast and easy for DIYers and installers alike.



Black



Red



Green



Brown

CORRAPOL®-BT Super Ridge End Caps fit into the lower slot on both sides of the CORRAPOL®-BT Super Ridge.



CORRAPOL®-BT : Aluminium Ridge Bar End Cap	Code
CORRAPOL®-BT Super Ridge End Cap - Black	AC340BL
CORRAPOL®-BT Super Ridge End Cap - Brown	AC340BR
CORRAPOL®-BT Super Ridge End Cap - Green	AC340GR
CORRAPOL®-BT Super Ridge End Cap - Red	AC340RE

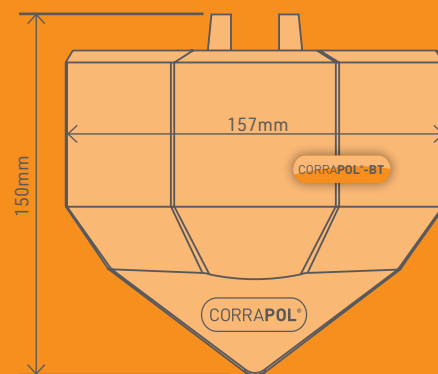

PLAN VIEW

CORRAPOL® Super Ridge End Cap fits into the lower slot of the CORRAPOL® Super Ridge.

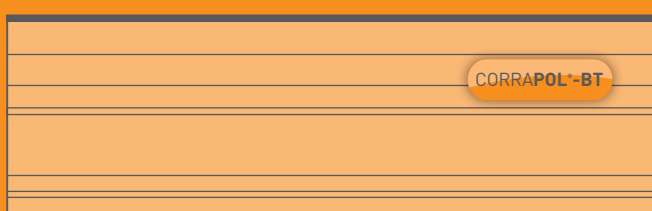

Cross Section of the CORRAPOL®-BT Super Ridge

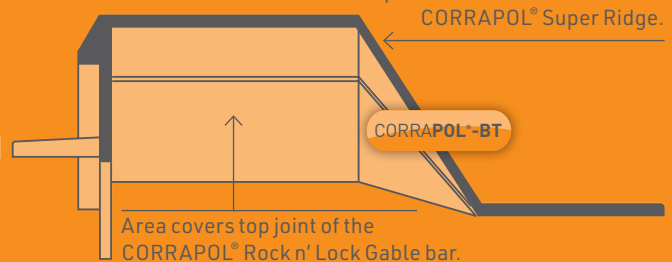

Cross Section of the CORRAPOL®-BT Super Ridge End Cap

CORRAPOL®-BT: Aluminium Top Wall Flashing

Our new CORRAPOL®-BT Top Wall Flashing is another innovation designed with ease of installation and quality finish in mind. With its unique bi-angled shape the Top Wall Flashing works with multiple roof pitches making it easy for any installer to add to their roof. The unique patented and/or Registered Design foam gaskets help create a firm seal on the CORRAPOL®-BT sheets below, whilst working with any pitch, ensuring strong waterproofing across the top of the roof. As with our other innovative aluminium components, the CORRAPOL®-BT Top Wall Flashing is manufactured to match the colours of the sheets in vibrant Red, Green, Black and Brown!

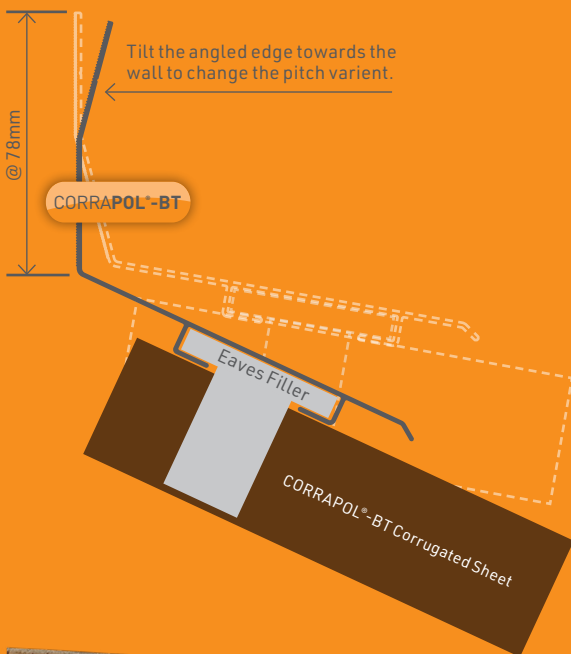

Black

Red



Green



Brown

CORRAPOL®-BT: Top Wall Flashing	Code
CORRAPOL®-BT Top Wall Flashing 2m - Black	AC620BL
CORRAPOL®-BT Top Wall Flashing 2m - Brown	AC620BR
CORRAPOL®-BT Top Wall Flashing 2m - Green	AC620GR
CORRAPOL®-BT Top Wall Flashing 2m - Red	AC620RE
CORRAPOL®-BT Top Wall Flashing 3m - Black	AC622BL
CORRAPOL®-BT Top Wall Flashing 3m - Brown	AC622BR
CORRAPOL®-BT Top Wall Flashing 3m - Green	AC622GR
CORRAPOL®-BT Top Wall Flashing 3m - Red	AC622RE
CORRAPOL®-BT Top Wall Flashing 6m - Black	AC628BL
CORRAPOL®-BT Top Wall Flashing 6m - Brown	AC628BR
CORRAPOL®-BT Top Wall Flashing 6m - Green	AC628GR
CORRAPOL®-BT Top Wall Flashing 6m - Red	AC628RE

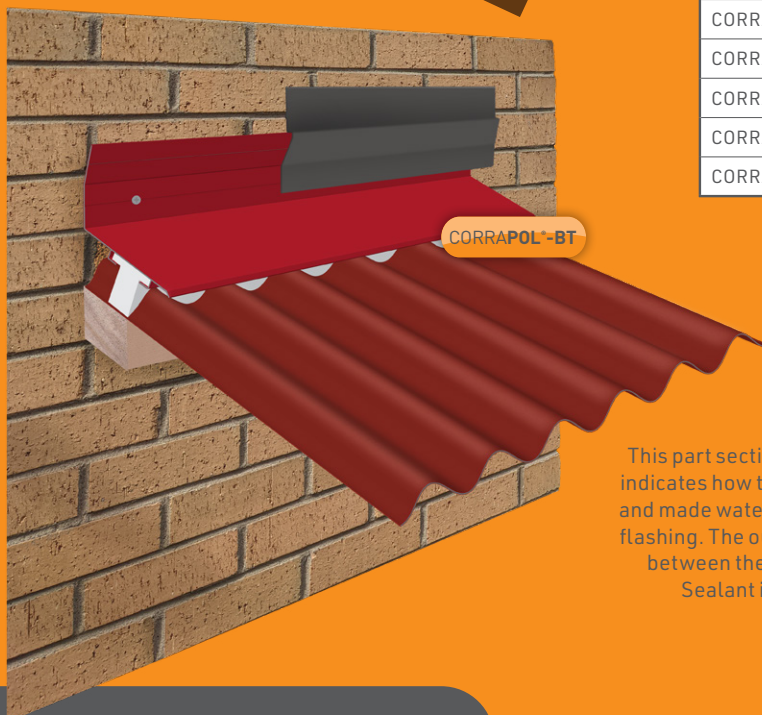

This part section illustration of the CORRAPOL®-BT Top Wall Flashing indicates how the flat angle verticle edge is fixed directly onto the wall and made waterproof by covering the angled side and fixings with lead flashing. The outer edges of the CORRAPOL®-BT Top Wall Flashing fits between the CORRAPOL®-BT Rock n' Lock Gable and Wall Flashing. Sealant is added to the joining edges to give a waterproof finish.

CORRAPOL®-BT : Budget Ridge

This CORRAPOL®-BT Budget Ridge provides a low cost Ridge Cover. Manufactured from the same bitumen product as the sheets, it provides a waterproof finish, but is not as robust or well-sealed as the CORRAPOL®-BT Super Ridge. Manufactured in four colours this CORRAPOL®-BT Budget Ridge is simply fixed with CORRAPOL®-BT Fixing Pins or CORRAPOL®-BT Flexible Screw Caps.

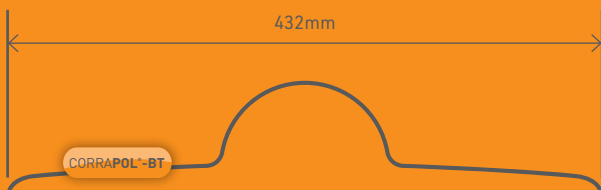

CORRAPOL-BT Corrugated Bitumen Roof Budget Ridge



Black



Red



Green



Brown

CORRAPOL®-BT: Ridge	Size	Code
Corrugated Bitumen Ridge - Black	1000 mm	AC118BL
Corrugated Bitumen Ridge - Red	1000 mm	AC118RE
Corrugated Bitumen Ridge - Green	1000 mm	AC118GR
Corrugated Bitumen Ridge - Brown	1000 mm	AC118BR

CORRAPOL®-BT : Foam Eaves Filler

CORRAPOL®-BT Foam Eaves Filler is manufactured from a flexible foam allowing successful sealing and draught proofing. The CORRAPOL®-BT Foam Eaves Filler is made with closed-cell foam so does not absorb moisture and can also be used to further improve waterproof sealing.



CORRAPOL®-BT: Eaves Filler	Quantity	Code
Corrugated Bitumen Foam Eaves Filler	4 pack	AC120

CORRAPOL®-BT : Superior Flexible Fixings

The Superior CORRAPOL®-BT flexible fixings provide enhanced sealing to the contours of the curved peaks of the CORRAPOL®-BT sheets. Being a screw fixing they also enable the installer to control the fixing pressure, and allow removal of the fixings if needed. The concealed caps in any colour pervade and aesthetically pleasing finish to the fixing hiding the screw heads.

CORRAPOL®-BT: Screw Caps	Quantity	Code
60mm Flexi Screw Cap Fixing - Black	10 Pack	AC30BL
60mm Flexi Screw Cap Fixing - Black	50 Pack	AC32BL
60mm Flexi Screw Cap Fixing - Red	10 Pack	AC30RE
60mm Flexi Screw Cap Fixing - Red	50 Pack	AC32RE
60mm Flexi Screw Cap Fixing - Green	10 Pack	AC30GR
60mm Flexi Screw Cap Fixing - Green	50 Pack	AC32GR
60mm Flexi Screw Cap Fixing - Brown	10 Pack	AC30BR
60mm Flexi Screw Cap Fixing - Brown	50 Pack	AC32BR

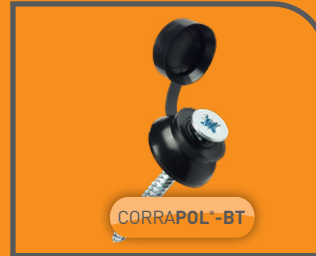

Black

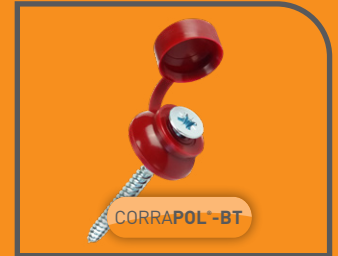

Red



Green

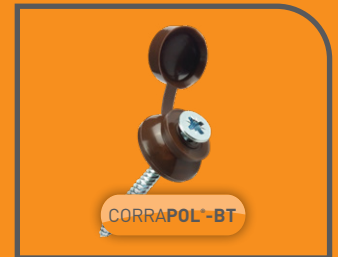

Brown

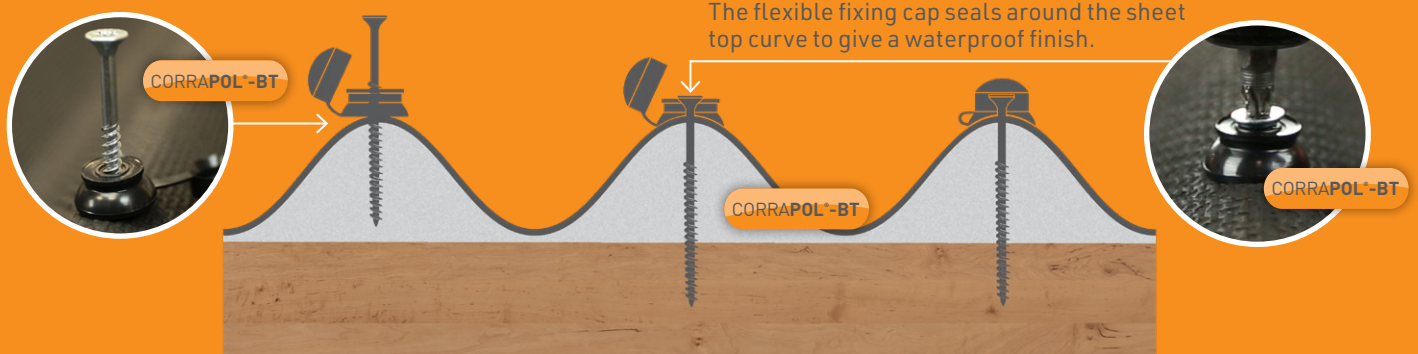

CORRAPOL®-BT : Fixing Pins

These budget fixings are available in each of the four matching colours and provide a faster and simple fixing method.

CORRAPOL®-BT: Fixing Pins	Quantity	Code
Corrugated Bitumen Fixing - Black	100 Pack	AC108BL
Corrugated Bitumen Fixing - Red	100 Pack	AC108RE
Corrugated Bitumen Fixing - Green	100 Pack	AC108GR
Corrugated Bitumen Fixing - Brown	100 Pack	AC108BR



Black



Red

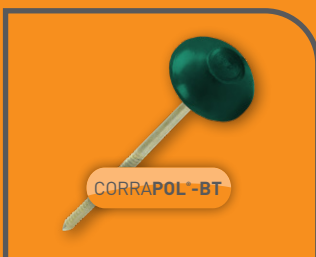

Green



Brown

Other Ranges We Manufacture

Please get in touch for more information about the many other products we manufacture.



WARNING : REGISTERED DESIGNS & PATENTS

The IP of the designs in this brochure are protected by internationally registered design rights. Many products are also protected with active or pending Patents. Clear Amber will not hesitate to take appropriate legal action if its rights in this respect are infringed.

© Copyright – Clear Amber Group Ltd – September 2023. No part of this publication may be copied, reproduced, scanned, or stored in any electronic database, whether in whole or in part, in any form or by any means, without permission in writing from Clear Amber. Clear Amber will not hesitate to take appropriate legal action if its rights in this respect are infringed.

Inasmuch as Clear Amber have no control over the circumstances in which our material may be used, or site specific parameters, we cannot guarantee that any particular results will be achieved. Users should carry out their own tests to determine the suitability of the material for their application.